



**-150pln**



**-250pln**



**-200pln**



**-200pln**



GRUPA **SBS**  
**KELLER**

**-200pln**



**-200pln**



Promocja za zakup  
produktów z marki  
KELLER by ELterm

- za minimum 1500 złoty netto\* = 1 kubek
- powyżej 2500 złoty netto\* = 3 kubki

\* wg cen katalogowych



GRUPA **SBS**  
**KELLER**

30 LAT  
ELTERM



**KOSZTY TRANSPORTU**

Dowolny mix produktów KELLER i ELTERM za minimum 1500 pln netto ceny katalogowej na koszt firmy ELTERM.



Promocja wrzesień - październik 2024  
ceny netto pln

GRUPA **SBS** **KELLER**



Promocja wrzesień - październik 2024 - Kawaleria Eltermu tnie ceny

## W akcji rycerz Grzegorz



Czołowy znawca asortymentu do pomp ciepła

- dogrzewaczy Strzelec, Bosman LED, Ułan LED
- modułów hydraulicznych Ułan, Komandor, Admirat
- Kontradmirał, jednostki wewnętrznej do pomp ciepła typu monoblok

Dogrzewacz układu c.o. STRZELEC

KELLER

**-150**



kod produktu	cena netto katalogowa	moc max
214004	<del>1599 pln</del> <b>1449 pln</b>	4,5 kW
214006	<del>1649 pln</del> <b>1499 pln</b>	6 kW
<b>KELLER</b> KEL 721301	<del>1649 pln</del> <b>1499 pln</b>	6 kW



Zielona energia  
program czyste powietrze

Dogrzewacz układu c.o. STRZELEC PRO  
z funkcją sprzęgła hydraulicznego



**-250**

kod produktu	cena netto katalogowa	moc max
224004	<del>1899 pln</del> <b>1649 pln</b>	4,5 kW
224006	<del>1949 pln</del> <b>1699 pln</b>	6 kW

## W akcji rycerz Grzegorz



Panel sterujący  
LED

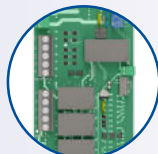

Wielofunkcyjny układ  
sterujący

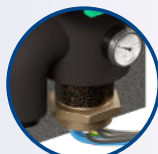

Grzałka elektryczna  
3/6/9 i 12 kW



Zawór bezpieczeństwa,  
termomanometr



Obudowa metalowa



2 x Mufa 6/4" Gw

## Ułan LED / **KELLER EcoHeater**



**-200**

### Panel LED



Zielona energia  
program czyste powietrze



Elektroniczny  
panel sterujący

Licznik pracy  
Bosmana LED

- nastawa zużycia energii
- sygnał zatrzymania pracy



Koniec limitu

Rozłącza kocioł gazowy gdy załączy się dogrzewacz. Załącza kocioł gazowy gdy skończy się zadany limit zużycia energii.



Zewnętrzny termostat  
beznapięciowy (0V)

Programowanie pracy



Sterowanie pompą c.o.

Możliwość sterowania zewnętrzną pompą c.o. niezależnie od źródła ciepła

kod produktu	cena katalogowa netto	moc max
264003 KEL 724388	<del>2749 pln</del> 2549 pln	3 kW
264006 KEL 724395	<del>2849 pln</del> 2649 pln	6 kW
264009 KEL 721318	<del>2849 pln</del> 2649 pln	9 kW
264012 KEL 724401	<del>2949 pln</del> 2749 pln	12 kW



## W akcji rycerz Grzegorz



Panel sterujący  
LED

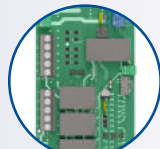

Wielofunkcyjny układ  
sterujący



Grzałka elektryczna  
3/6/8 i 12 kW



Ocieplenie EPP



Profil montażowy

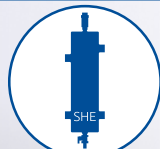

Uniwersalne podłączenie  
funkcja sprężta

## Bosman LED / **KELLER LED**



2 x Mufa 6/4" Gw



**-200**

kod produktu	cena netto katalogowa	moc max
234003 KEL 724357	<del>2199 pln</del> <b>1999</b> pln	3 kW
234006 KEL 724364	<del>2299 pln</del> <b>2099</b> pln	6 kW
234008 KEL 724371	<del>2299 pln</del> <b>2099</b> pln	8 kW
234012	<del>2399 pln</del> <b>2199</b> pln	12 kW

## Bosman LED PRO



4 x Mufa 5/4" Gw

**-200**

kod produktu	Bosman LED PRO	moc max
254003	<del>2349 pln</del> <b>2149</b> pln	3 kW
254006	<del>2449 pln</del> <b>2249</b> pln	6 kW
254008	<del>2449 pln</del> <b>2249</b> pln	8 kW
254012	<del>2549 pln</del> <b>2349</b> pln	12 kW

**W akcji  
rycerz  
Grzegorz**

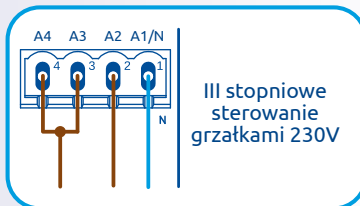
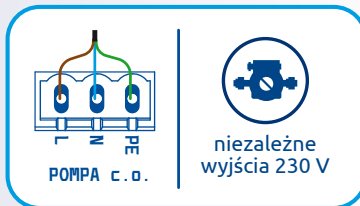
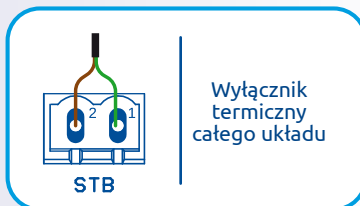

Dogrzewacze układu c.o. **KELLER PC**  
z automatyką do pomp ciepła

**-200**

kod produktu	cena netto katalogowa	moc max
244003 KEL 721554	<del>1999 pln</del> <b>1799 pln</b>	3 kW
244006 KEL 721561	<del>2099 pln</del> <b>1899 pln</b>	6 kW
244008 KEL 721578	<del>2099 pln</del> <b>1899 pln</b>	8 kW

Ułan PC  
Najbardziej zaawansowany układ sterujący w Polsce

**-200**



kod produktu	Ułan PC	moc max
330003	<del>2499 pln</del> <b>2299 pln</b>	3 kW
330006	<del>2599 pln</del> <b>2399 pln</b>	6 kW
330008	<del>2599 pln</del> <b>2399 pln</b>	9 kW
330012	<del>2699 pln</del> <b>2499 pln</b>	12 kW



**KELLER Condens 360° do 55 kW + 2 x grupa pompowa (pompa Green PRO)**

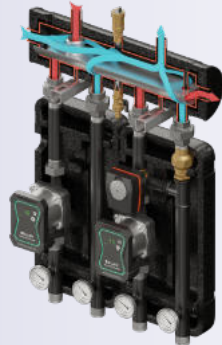

KEL 724470

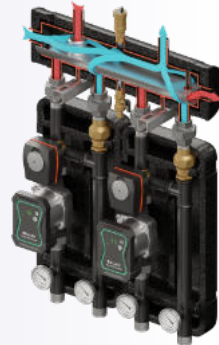

KEL 724487



zawór obrotowy  
progresywny  
3 drogowy  
VRG 432 1" Kvs do 8.0  
+ siłownik ARA



KEL 724494

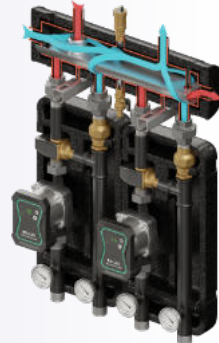

KEL 724500



zawór termostatyczny  
VTA 372 1", Kvs 3,4  
od 40 do 140 m<sup>2</sup>  
ΔT 5°C, 55 W/m<sup>2</sup>

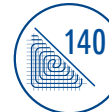

praca bokiem

obiegi grzewcze w górę

Zamieniamy miejscami odpowietrznik i zawór spustowy

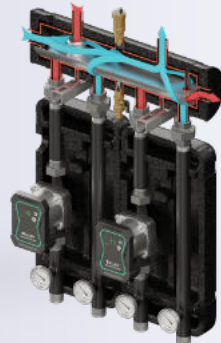

KEL 724463

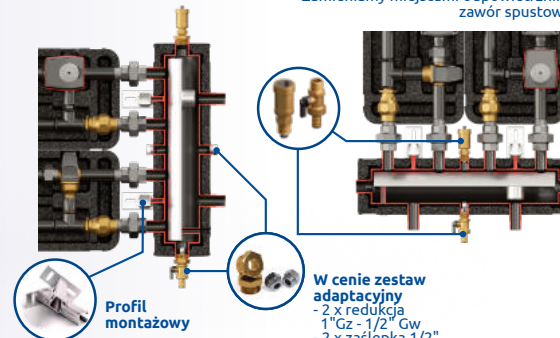

Profil  
montażowy

W cenie zestaw  
adaptacyjny  
- 2 x redukcja  
1" Gz - 1/2" Gw  
- 2 x zaślepka 1/2"



**KELLER**  
kompaktowy rozdzielacz 360° do 40 kW

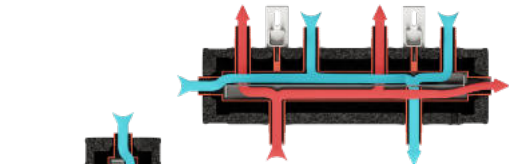
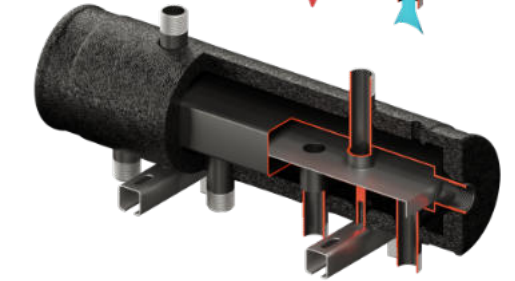
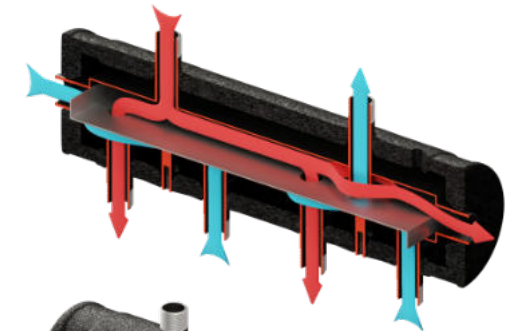

Jeden rozdzielacz  
4 pozycje ułożenia

360°

Moc	Nr katalogowy
40 kW	KEL 724456

konfigurator doboru pozostałych  
zestawów hydraulicznych  
na dwa i trzy obiegi grzewcze



**KELLER** Condens 360° do 55 kW + 3 x grupa pompowa (pompa Green PRO)

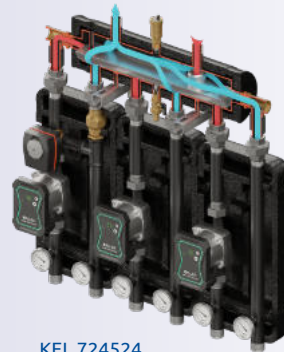

KEL 724524

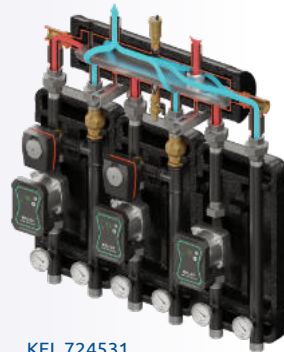

KEL 724531

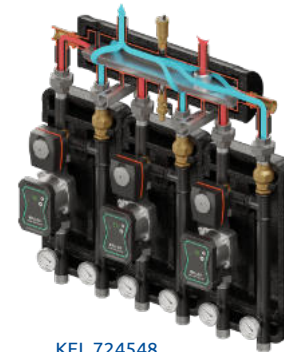

KEL 724548

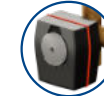

zawór obrotowy  
progresywny  
3 drogowy  
VRG 432 1" Kvs do 8.0  
+ siłownik ARA



zawór termostatyczny  
VTA 372 1", Kvs 3,4  
od 40 do 140 m<sup>2</sup>  
ΔT 5°C, 55 W/m<sup>2</sup>

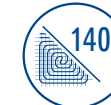

praca bokiem

W cenie  
zestawu  
profil  
montażowy



W cenie zestaw  
adaptacyjny  
- 2 x redukcja  
1" Gz - 1/2" Gw  
- 2 x zaślepka 1/2"

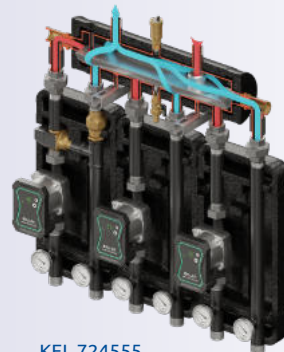
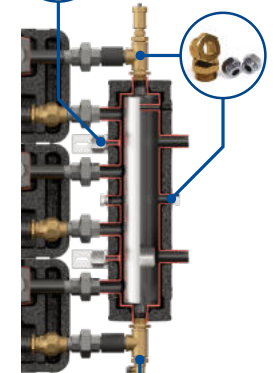

KEL 724555

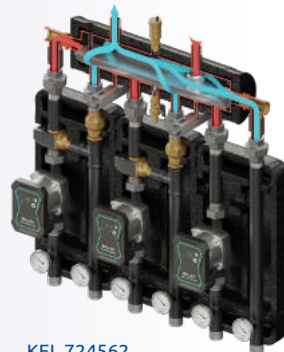

KEL 724562

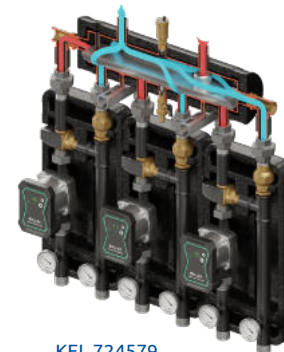

KEL 724579

obiegi grzewcze w górę

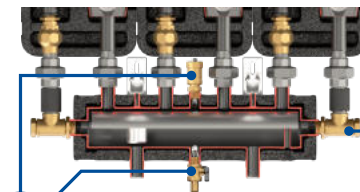

Zamieniamy miejscami  
odpowietrznik i zawór  
spustowy

W cenie zestawu  
pakiet rozszerzający

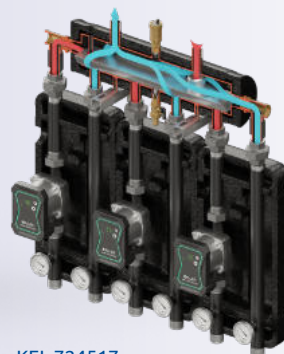

KEL 724517





**KELLER Condens**  
Sprzęgło hydrauliczne

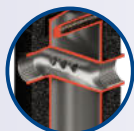

Kierownica przepływu



kołnierz DN (PN16)  
65-2 1/2"

Moc	Nr katalogowy
300 kW	KEL 724432



Moc	Nr katalogowy
55 kW	KEL 719674
90 kW	KEL 719681
135 kW	KEL 719698
210 kW	KEL 719704



**KELLER z ociepleniem**  
Sprzęgło hydrauliczne



rurka pomiarowa



kołnierz DN (PN16)  
65-2 1/2"

Moc	Nr katalogowy
225 kW	KEL 724449

Moc	Nr katalogowy
40 kW	KEL 715904
70 kW	KEL 715911
100 kW	KEL 715928
156 kW	KEL 715935



**KELLER Condens 360° do 55 kW**  
Sprzęgło kolektor-hydrauliczne

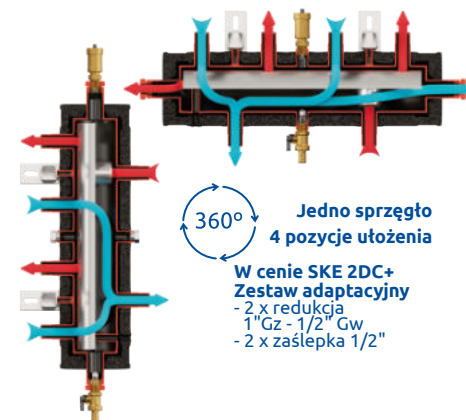
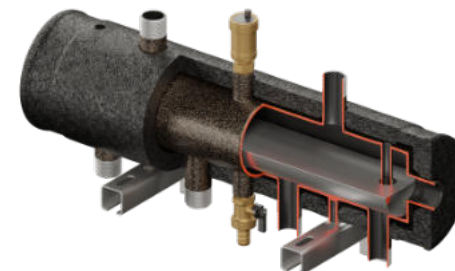
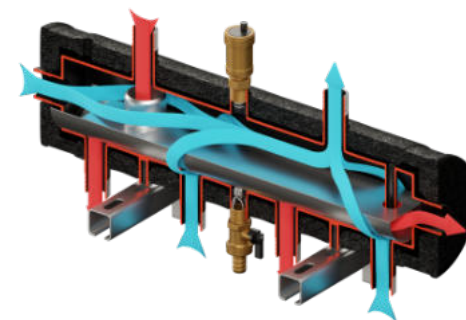

360°  
Jedno sprzęgło  
4 pozycje ułożenia

W cenie SKE 2DC+  
Zestaw adaptacyjny  
- 2 x redukcja  
1" Gz - 1/2" Gw  
- 2 x zaślepka 1/2"

Moc	Nr katalogowy
55 kW	KEL 718301



**KELLER**  
EcoPower LED  
(odpowiednik Major)



**Kocioł 15 kW**  
regulacja mocy  
4/6/9/15 kW

**Kocioł 18 kW**  
regulacja mocy  
4/6/12/18 kW

**EDM** Elektroniczny dobór mocy  
w zależności od chwilowych  
potrzeb

**KELLER**  
EcoPower LCD  
(odpowiednik Pułkownik)

w cenie kotła:  
sterowanie przewodowe

 pokojowe  pogodowe



	Automatyka LED	Automatyka LCD
Keller EcoPower 15/9/6/4 kW	KEL 724418	KEL 720175
Keller EcoPower 18/12/6/4 kW	KEL 724425	KEL 720182
pakiet c.w.u.	KEL 720199	KEL 720199
moduł + aplikacja internetowa		KEL 720205

Wielofunkcyjny wyświetlacz



9 programów c.o.



9 programów c.w.u.  
i pompy cyrkulacyjnej



Licznik pracy kotła



Redukcja mocy maksymalnej



**OPCJA LCD**



Moduł + aplikacja internetowa  
KEL 720205

Steruje wszystkimi funkcjami kotła:

- monitorowanie wszystkich temperatur
- zdalna możliwość zmian temperatur
- podgląd wykresów temperatur

**OPCJA LCD**

Radiowe sterowanie - 3 warianty do wyboru



radiowe sterowanie pokojowe i pogodowe kod 100009



radiowe sterowanie tylko pokojowe kod 100010



radiowe sterowanie tylko pogodowe kod 100011

**OPCJA LCD**



Elektrozawór trójdrogowy + siłownik

pakiet c.w.u.  
KEL 720199



progr. tygod. c.w.u.



Czujnik temp. c.w.u. do zasobnika



progr. tygod. pompy cyrkul.

**OPCJA LCD**



2 x czujnik do bufora

Pakiet do bufora kod 100013



program tygodniowy bufora

## Rycerz Grzegorz

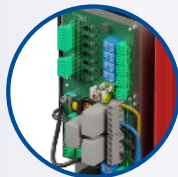

Zaawansowany układ sterujący



Zawór bezpieczeństwa

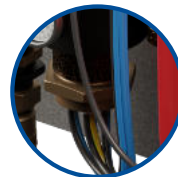

Grzałka elektryczna 3/6/9/12 kW



Separator magnetyczny (Admirat PC Komandor PC)



Pompa c.o. (opcja)



Naczynie przeponowe c.o. (opcja)



Admirat PC



Komandor PC

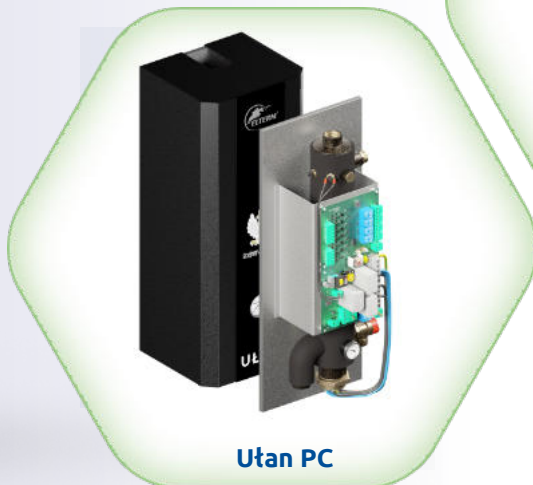

Ułana PC

Najbardziej zaawansowany układ sterujący w Polsce



mini katalog

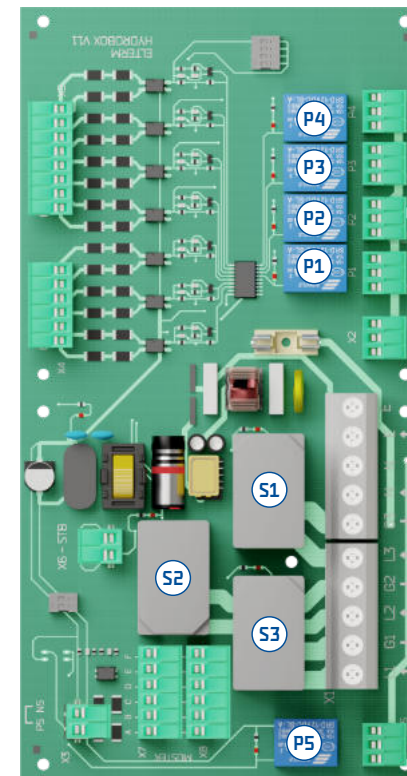



## ZNAJDŹ WIĘCEJ



katalog produktów



konfigurator doboru kocioł i dogrzewaczy



konfigurator doboru armatury hydraulicznej



cennik

## Katalogi tematyczne



kotły elektryczne dogrzewacze c.o.



armatura hydrauliczna



moduły hydrauliczne

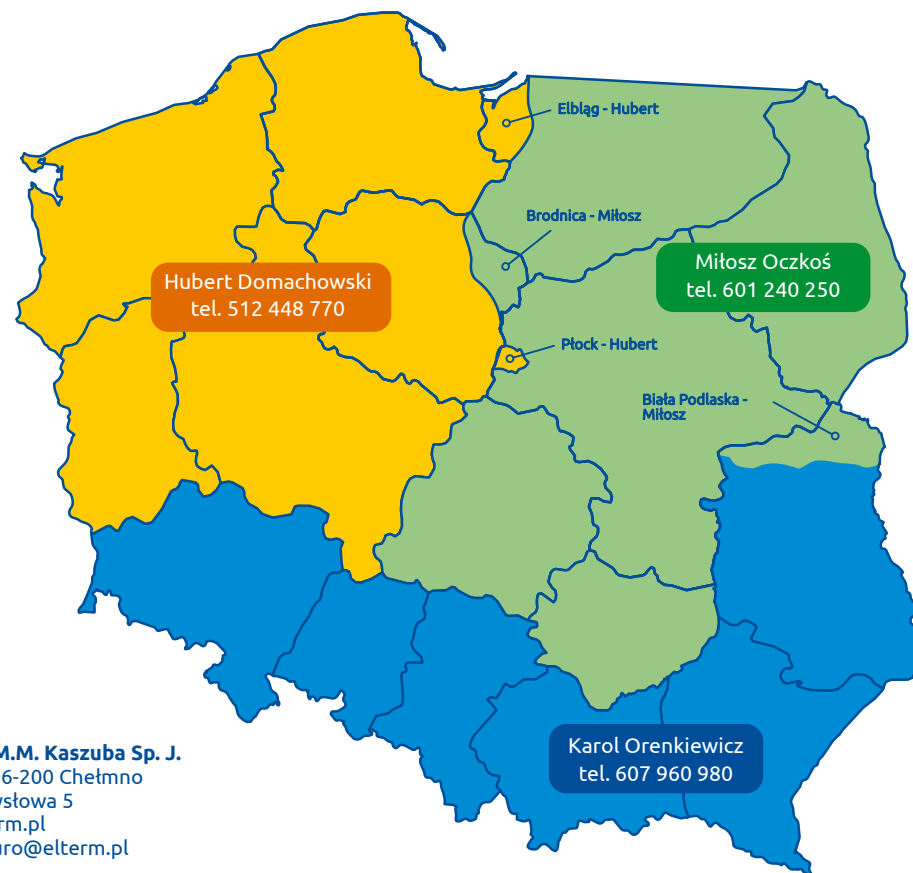

**ELTERM M.M. Kaszuba Sp. J.**  
POLSKA 86-200 Chełmno  
ul. Przemysłowa 5  
www.elterm.pl  
e-mail: biuro@elterm.pl

**Dział handlowy:**  
tel. 667 005 000  
56 686 93 05 w. 21 i 22

**Dyrektor handlowy - Szkolenia**  
Grzegorz Orenkiewicz  
tel. 512 225 307