

W cenie SKE 2DC+ Condens

Zestaw adaptacyjny

- 2 x redukcja 1" Gz - 1/2" Gw
- 2 x zaślepka 1/2"



Zestaw KOMPANIA
cztery pozycje instalacji zestawu

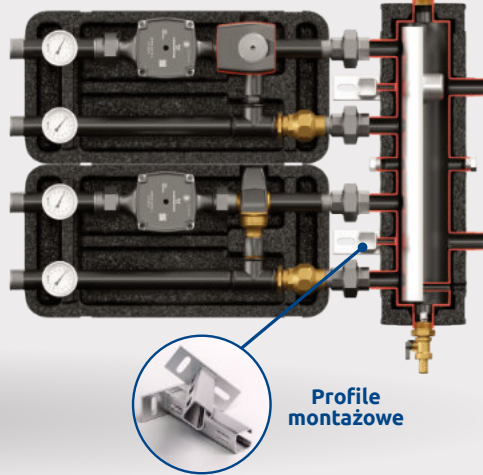
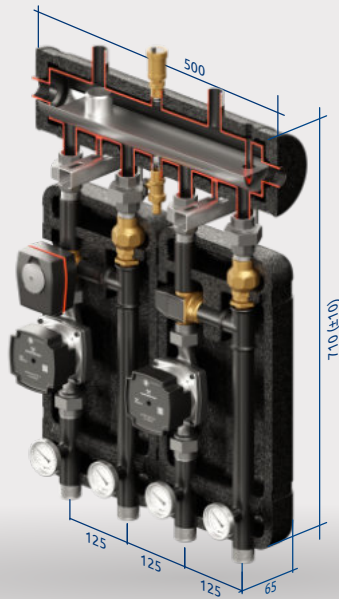
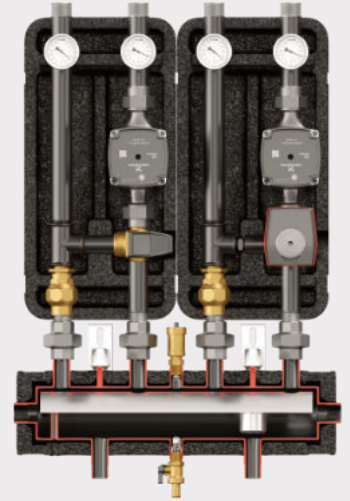

Profile montażowe

Zestaw KOMPANIA - do wyboru 28 kombinacji (VRG, VTA, UNI)



Ochrona powrotu kotła np. zawór ESBE VTC



Patent P.421240

kierownica przepływu

Wyjścia boczne:
- 2 źródła ciepła
- 3 obiegi grzewcze

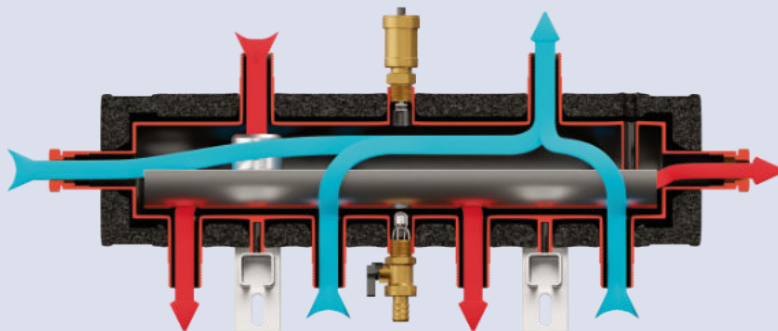

Wyjścia boczne:
- 2 źródła ciepła
- 3 obiegi grzewcze

Do wyboru 4 rodzaje grup pompowych



Zawór obrotowy ESBE VRG 432



do 50 kW do 280 m²



Zawór mieszający ESBE VTA 522



do 120 m²



Zawór mieszający ESBE VTA 322



do 60 m²



Uniwersalna UNI

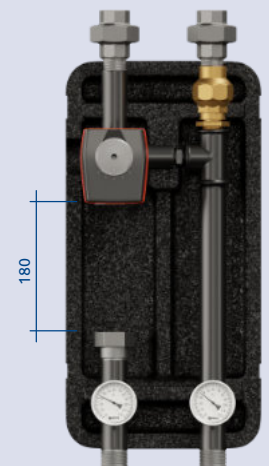

Uniwersalna rozstaw 180 mm
Dostępna wersja bez pompy (VRG, VTA, UNI)

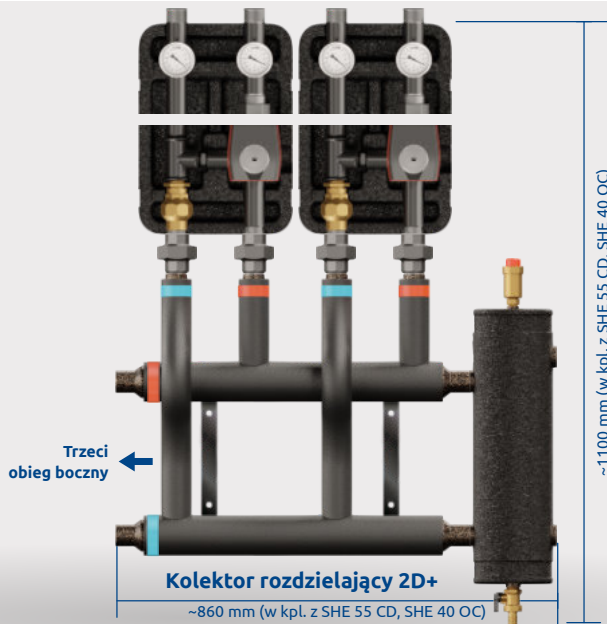

SHE-OC



SHE-CDI INOX
SHE-CD



Patent P.421240
kierownica przepływu



pompa ciepła



kocioł kondensacyjny

A+++

Kolektory rozdzielające 38 modeli - Sprzęgła hydrauliczne 32 modele - Grupy pompowe 10 modeli

Do wyboru 4 rodzaje grup pompowych

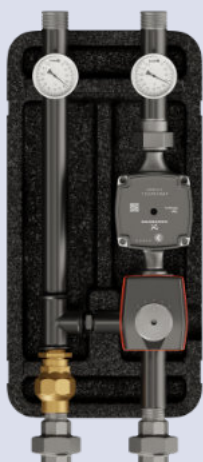

Zawór obrotowy
ESBE VRG 432



do 50 kW do 280 m²

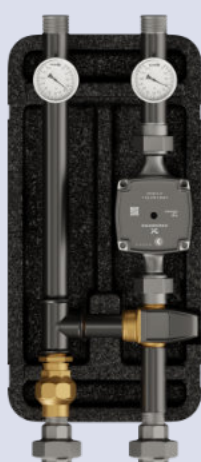

Zawór mieszający
ESBE VTA 522



do 120 m²

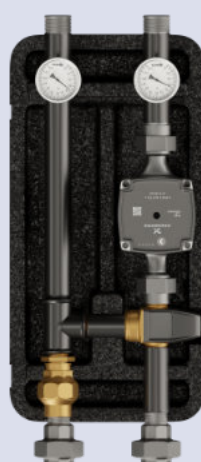

Zawór mieszający
ESBE VTA 322



do 60 m²



Uniwersalna
UNI



Uniwersalny
rozstaw 180 mm
Dostępna wersja bez
pompy (VRG, VTA, UNI)

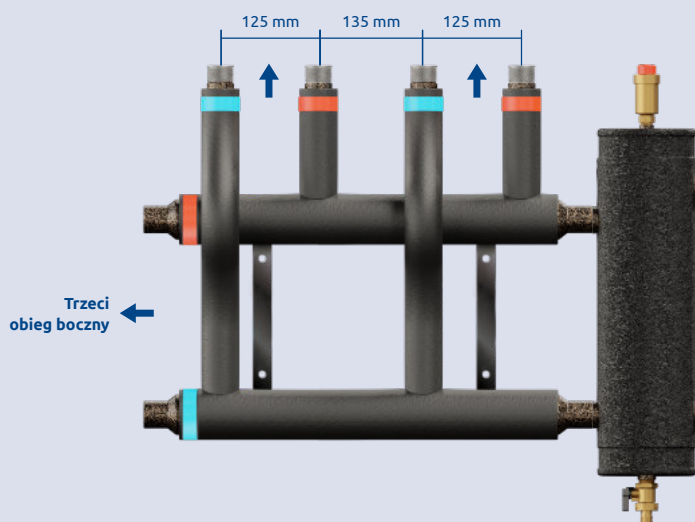

Do współpracy z każdym
źródłem ciepła

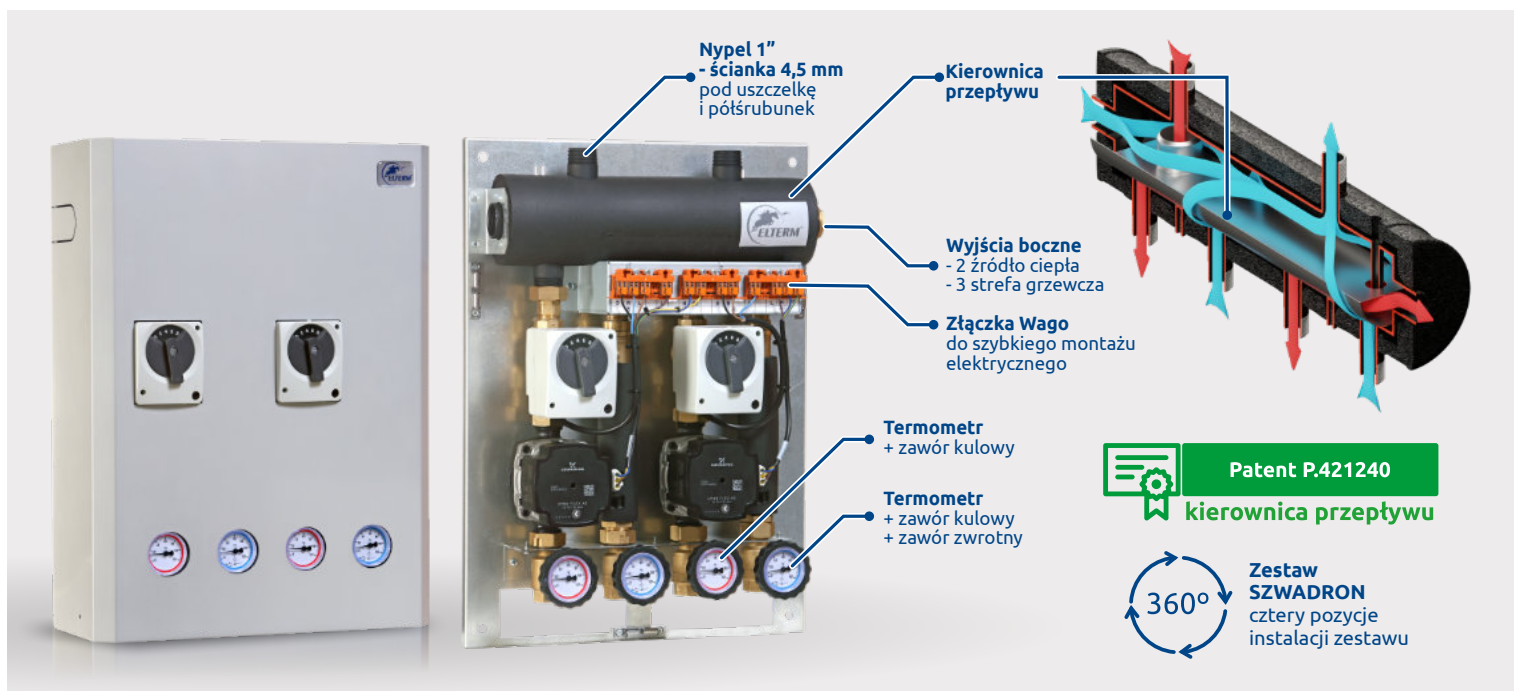

Zestaw Szwadron - 6 opcji do wyboru



SZWADRON 070
(SKE 2DC+ 35 kW, 2 x UNI, pompy DN15)
kod towaru 835070



SZWADRON 370
(SKE 2DC+ 35 kW, UNI, zawór mieszający
termostatyczny, pompy DN15)
kod towaru 835370



SZWADRON 373
(SKE 2DC+ 35 kW, 2 x zawór mieszający
termostatyczny, pompy DN15)
kod towaru 835373



SZWADRON 384
(SKE 2DC+ 35 kW, zawór mieszający
termostatyczny, z. obrotowy z siłownikiem,
pompy DN15)
kod towaru 835384



SZWADRON 480
(SKE 2DC+ 35 kW, UNI, zawór obrotowy
z siłownikiem, pompy DN15)
kod towaru 835480



SZWADRON 484
(SKE 2DC+ 35 kW, 2 x zawór obrotowy
z siłownikiem, pompy DN15)
kod towaru 835484

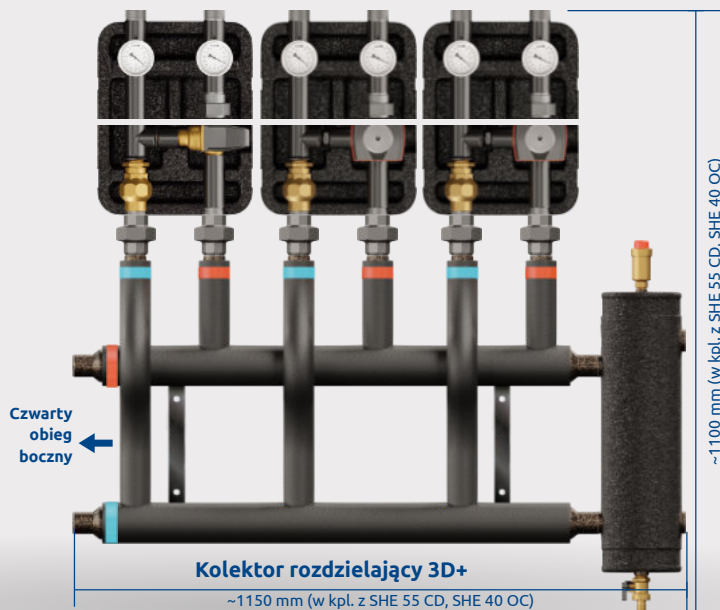

SHE-OC

SHE-CDI INOX
SHE-CD



Patent P.421240
kierownica przepływu



pompa ciepła



kocioł kondensacyjny

A+++

Kolektory rozdzielające 38 modeli - Sprzęgła hydrauliczne 32 modele - Grupy pompowe 10 modeli

Do wyboru 4 rodzaje grup pompowych

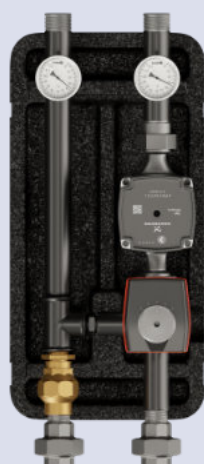

Zawór obrotowy
ESBE VRG 432



do 50 kW



do 280 m²

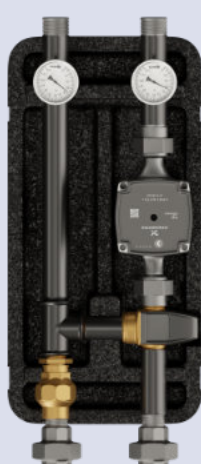

Zawór mieszający
ESBE VTA 522



do 120 m²

Kvs 3,2



Zawór mieszający
ESBE VTA 322



do 60 m²

Kvs 1,2



Uniwersalna
UNI



Uniwersalny
rozstaw 180 mm
Dostępna wersja bez
pompy (VRG, VTA, UNI)

180

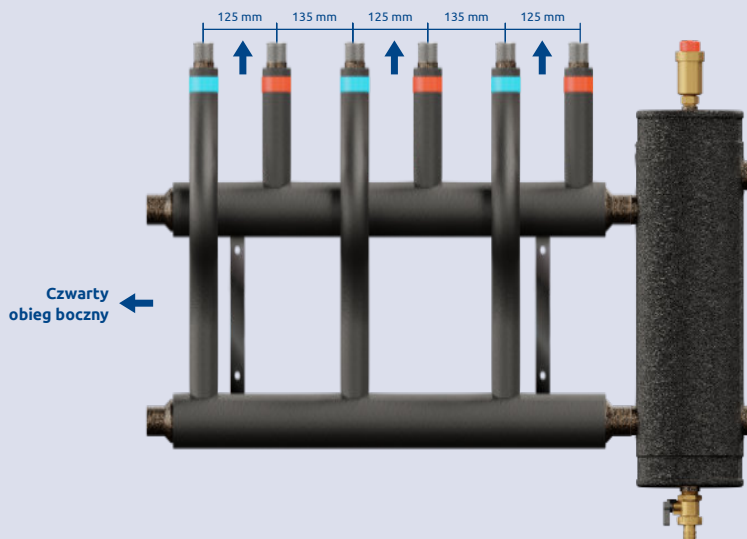

Do współpracy z każdym
źródłem ciepła

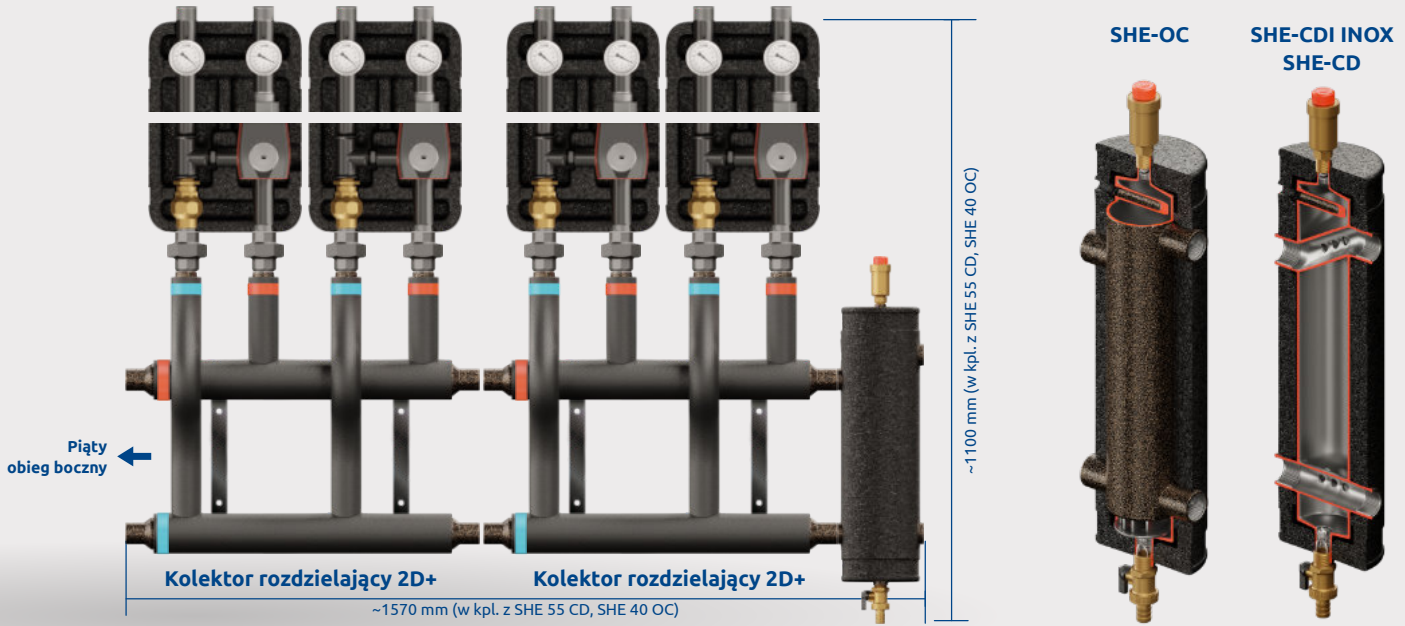

Kolektory rozdzielające 38 modeli - Sprzęt hydrauliczny 32 modele - Grupy pompowe 10 modeli

Do wyboru 4 rodzaje grup pompowych

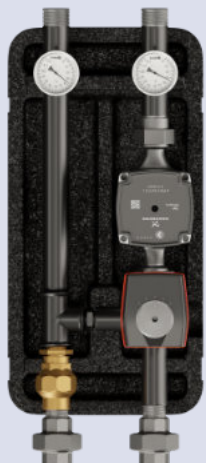

Zawór mieszający obrotowy
ESBE VRG 432



do 50 kW



do 280 m²

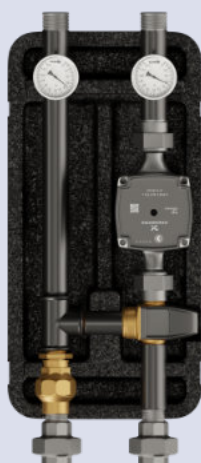

Zawór mieszający termostatyczny
ESBE VTA 522



do 120 m²

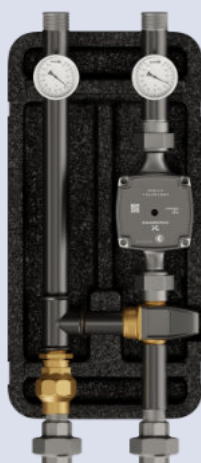

Zawór mieszający termostatyczny
ESBE VTA 322



do 60 m²



Uniwersalna
UNI

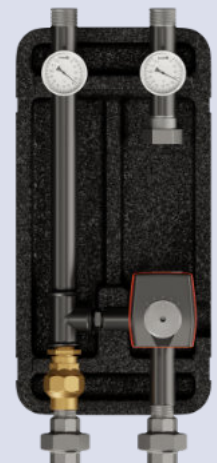

Uniwersalny rozstaw 180 mm
Dostępna wersja bez pompy (VRG, VTA, UNI)

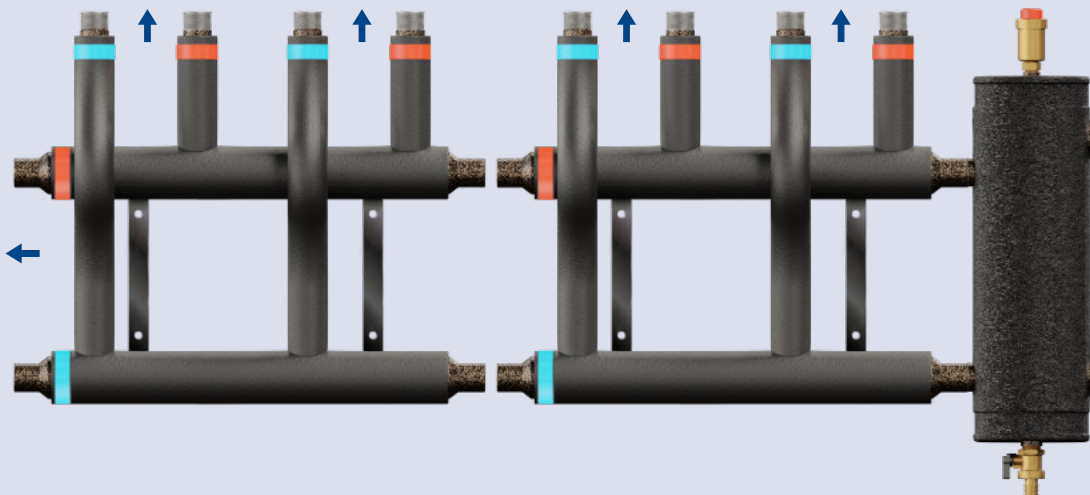

Do współpracy z każdym źródłem ciepła

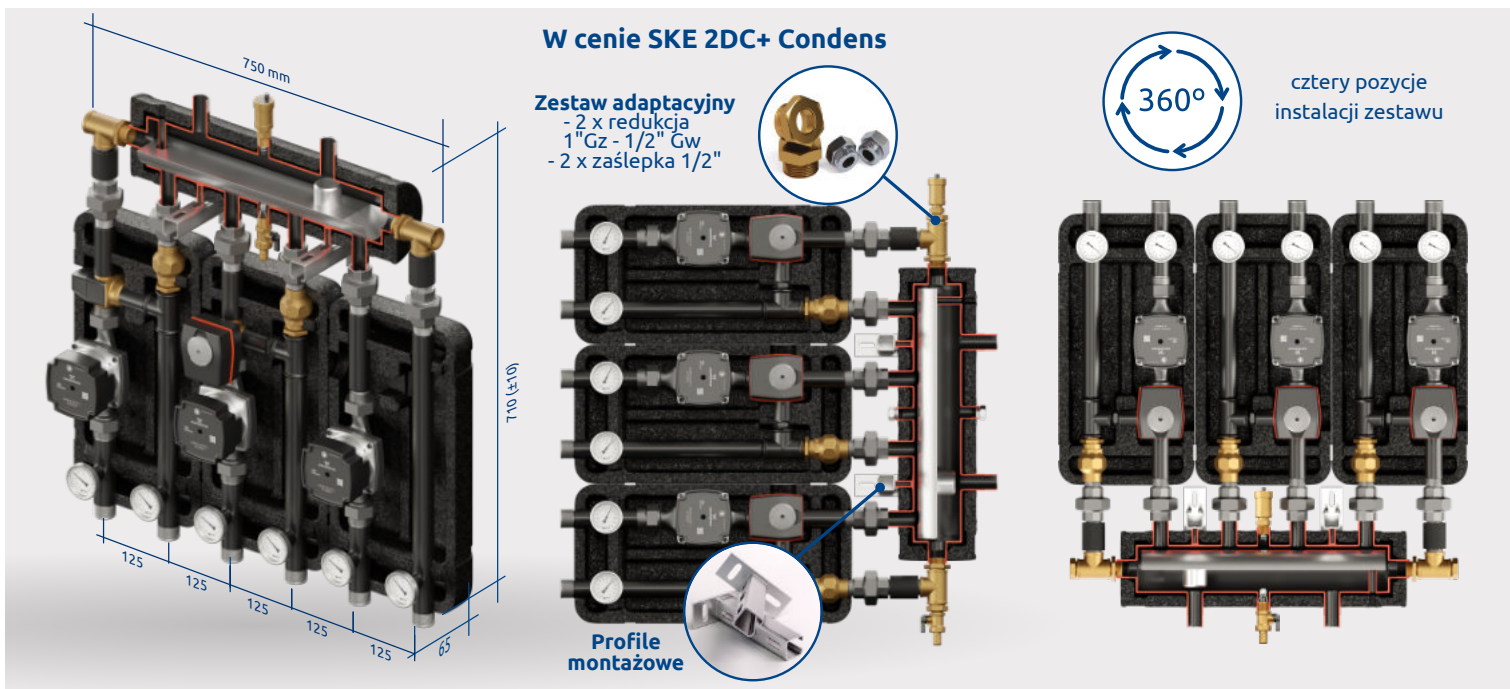

SKE 2DC+ Condens + 3x grupa pompowa = 220 kombinacji



Ochrona powrotu kotła
np. zawór ESBE VTC



Patent P.421240

kierownica przepływu

Wyjścia boczne:
- 2 źródła ciepła
- 4 obiegi grzewcze

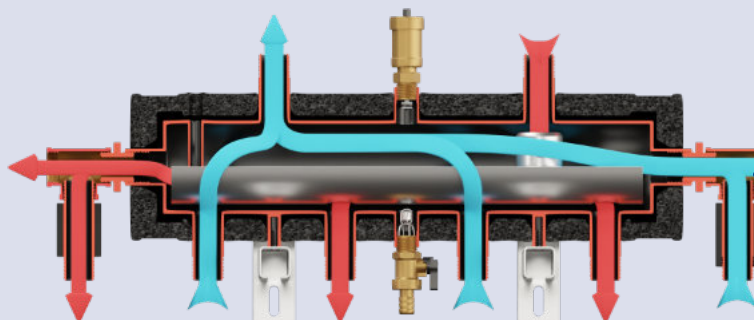

Wyjścia boczne:
- 2 źródła ciepła
- 4 obiegi grzewcze



Pakiet
rozszerzający

Do wyboru 4 rodzaje grup pompowych



Zawór obrotowy
ESBE VRG 432



do 50 kW do 280 m²



Zawór mieszający
ESBE VTA 522



do 120 m²



Zawór mieszający
ESBE VTA 322



do 60 m²



Uniwersalna
UNI

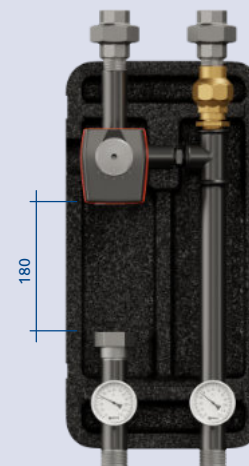

180

Uniwersalny
rozstaw 180 mm
Dostępna wersja bez
pompy (VRG, VTA, UNI)

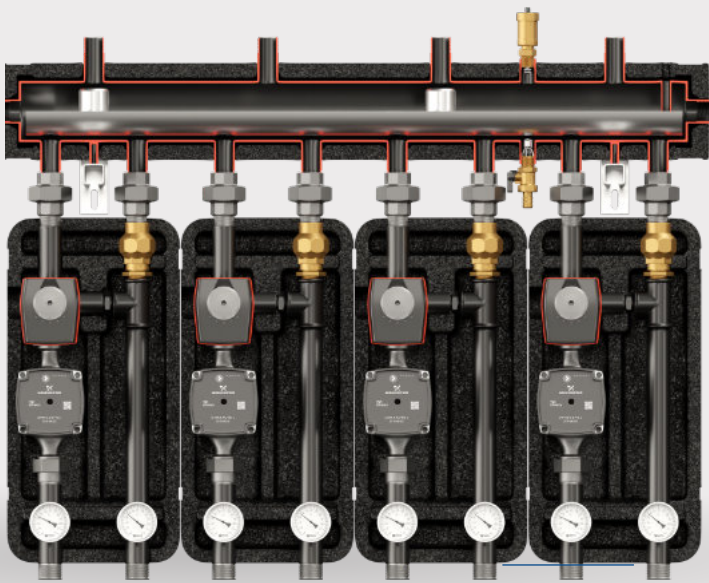

Zestaw adaptacyjny
- 2 x redukcja 1" Gz - 1/2" Gw
- 2 x zaślepka 1/2"



SKE + grupy pompowe
Trzy pozycje instalacji

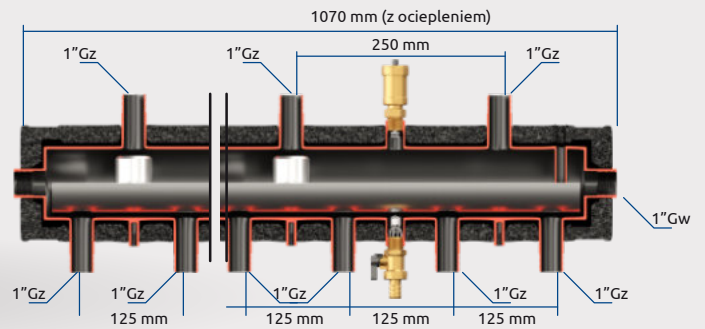

Profesjonalne rozwiązanie dla kotłowni: SKE 4DC+ Condens + 4 x grupa pompowa = 715 kombinacji



Ochrona powrotu kotła
np. zawór ESBE VTC



Patent P.421240

kierownica przepływu

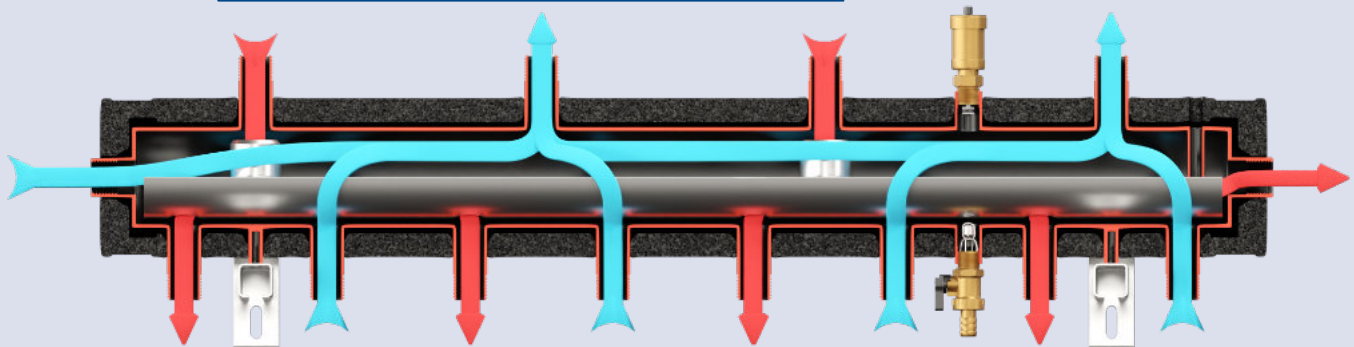

Do wyboru 4 rodzaje grup pompowych



Zawór obrotowy
ESBE VRG 432



do 50 kW do 280 m²



Zawór mieszający
ESBE VTA 522



do 120 m²



Zawór mieszający
ESBE VTA 322



do 60 m²



Uniwersalna
UNI

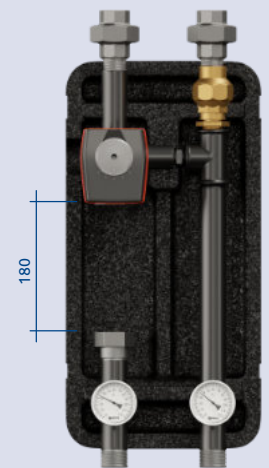

Uniwersalny
rozstaw 180 mm
Dostępna wersja bez
pompy (VRG, VTA, UNI)

180